

VITRAMIC 7250 K

AEG

Build-in Hotplate Unit

Einbau-Kochmulde

Instructions for use

Gebrauchsanweisung

AUS
ERFAHRUNG
GUT

It is essential to read these instructions and keep them in a safe place

(GB)

Contents	Page	Page
Illustrations	3-4	Care and cleaning of the hotplates 9
Equipment and description	5	Heavy soiling and stains 9
For the user		Installation instructions
Safety instructions	5	For the installer 10
Using the hotplates	7	For the kitchen furniture installer 11/12
Operation of the hotplates	8	

Gebrauchsanweisung unbedingt lesen und aufbewahren!

(D)

Inhaltsverzeichnis	Seite	Seite
Bildseiten	3/4	Einbauhinweise 17
Ausstattung	13	Typschild 17
Sicherheitsbestimmungen	13/14	Reinigung und Pflege 18
Bedienung der Kochstellen	14-16	



Printed on recycled paper. AEG – putting words into action.

Gedruckt auf Umweltschutzpapier – Wer ökologisch denkt, handelt auch so...

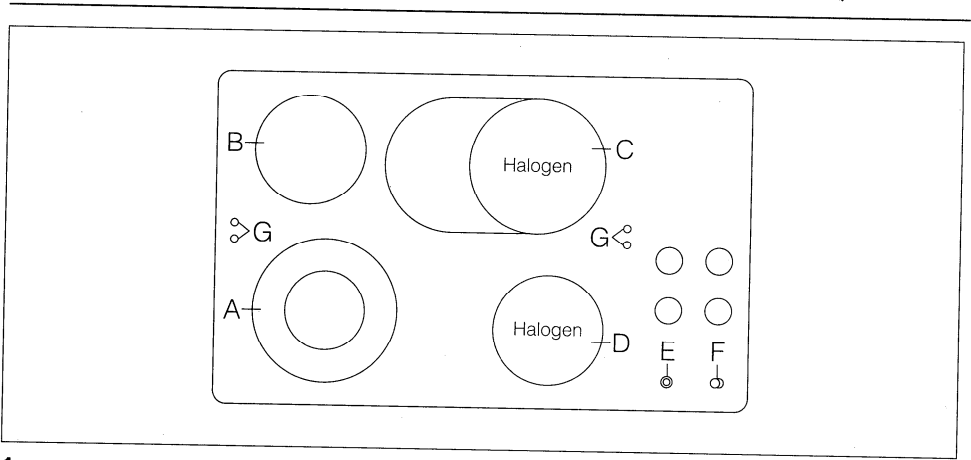

1

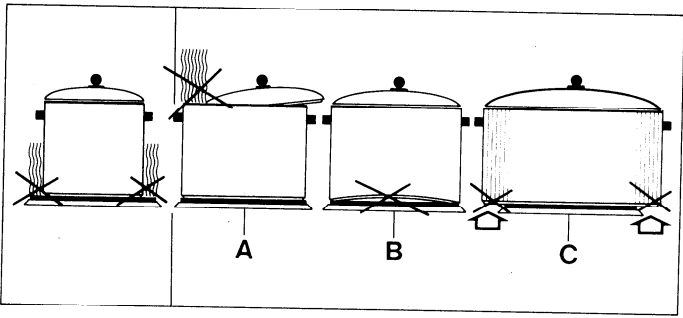

2

3

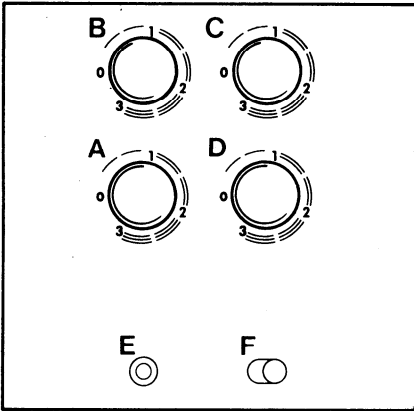

4

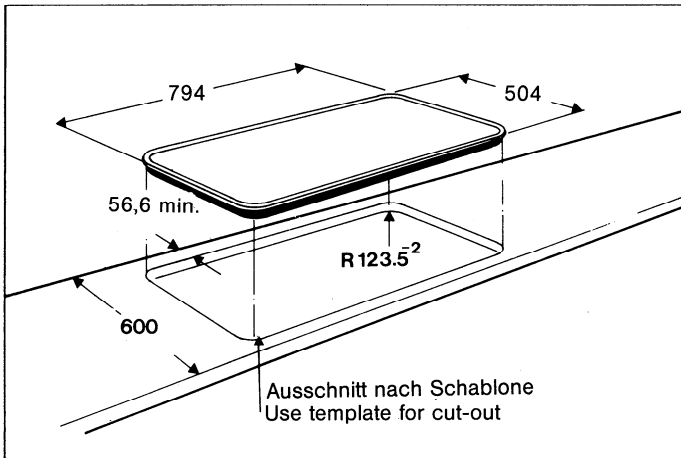

5

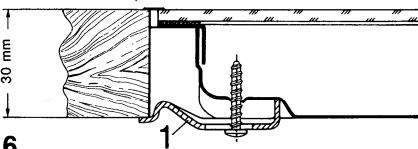

6

If the worktop height is less than 40 mm or when using marble or granite worktops the following installation set has to be ordered ET 661 915 500.

Bei Arbeitsplatten < 40 mm und Marmor- oder Granitarbeitsplatten muß der Montagesatz ET 661 914 500 (Spannpratzen) bestellt werden.

Figure 1

- A Dual circuit hotplate 12 cm and 21 cm \varnothing with corresponding switch
- B Hotplate 14.5 cm \varnothing with corresponding switch
- C Halogenroaster plate 18.0 cm x 29 cm with corresponding switch. The inner hotplate is Halogen
- D Halogenhotplate 14.5 cm \varnothing with corresponding switch
- E Touch control for dual zone
- F Touch control for roaster plate
- G Residual heat indicator

For the user

Safety instructions

To comply with safety regulations we must draw your attention to the following instructions:

- Only an approved electrical installer should connect your appliance. This ensures that the legal requirements and the connection regulations of your electricity supply authority applicable in your locality are complied with.
- **To maintain the safety of your appliance you should only have repairs, especially on live parts, carried out by a trained electrician. In the event of a fault, you should therefore approach your retailer or our AEG Service Department direct.**
- During cooking, the hotplates become hot. You should therefore keep small children well away.
- Overheated fats and oils rapidly ignite on hot hobs! Preparation of dishes with fats and oils (eg chipped potatoes) must always be supervised.
- Please make sure that the connection leads of other appliances (eg small appliances) do not come into contact with the hot hotplates.

Important

**Never use this appliance for heating purposes!
This appliance must never be operated
without supervision!**

Using the hotplates

The correct utensils

Always use pans with a flat base. Uneven pots and pans do not absorb the heat from the cooking zone properly, thus prolonging cooking times and causing permanent discolouration of the hob. For the same reason you should not use pans which are too small, but ones which are the same size as the cooking zone.

Always make sure the pan is placed on top of the cooking zone marks.

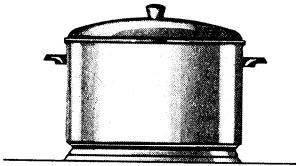

This is the correct pan. It has a thick, flat base which efficiently absorbs heat from the cooking zone and therefore protects it from overheating. It is larger than the cooking zone and protects it, like an umbrella, from spillage.

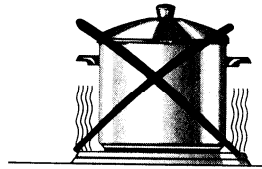

This pan is too small and wastes heat. Moreover, any spillage burns on the hob surface and is then very difficult to remove.

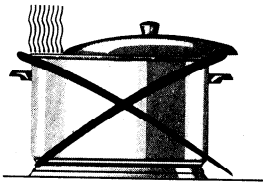

Do not put wet pans or steaming lids on cooking zones that are not in use. Water and steam inevitably produce calcareous deposits.

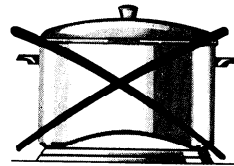

Never use pans with a thin, distorted base. They cause the cooking zone to overheat. The ideal pans have thick, flat bottomed bases.

The more suitable the utensil the more satisfactory the results will be. It is false economy to buy cheap utensils. Good quality utensils save power as they permit lower settings.

The important consideration in the quality of the pan in relation to hotplates is the pan base

and not – as is frequently assumed – the material from which the pan is made. The pan base should be as thick and as flat as possible. Ideal are sandwich bases (triple layer) which conduct the heat best.

Additional information concerning the Halogen hotplates

When using the Halogen plates avoid pans with shiny bases as they reflect the heat. This will result in the plate cycling on and off fairly frequently, extending cooking times.

Hints for cooking on the hotplates

- The ceramic glass is extremely resistant and strong, capable of withstanding light or moderate impacts without damage – but not unbreakable. Pointed and hard objects falling on the cooking area may damage it.
-

Using the hotplates

Important

If the surface is cracked or fractured, the hob must not be used. The hob should be switched off at the mains supply and AEG Service Department called immediately.

- After switching on the hob you will hear a faint hum. Do not be concerned. This noise is simply a feature of the radiant heating system and does not effect the operation of the hob.
- Your hob has four heat residual warning lights – these remain “lit” even when the cooking zone has been switched off, so long as the temperature of the ceramic surface is still dangerously high. The light goes out only when the temperature has fallen to a safe level.

- **Do not** leave articles standing on the hob.
- **Do not** prepare dishes in aluminium foil or plastic containers on heated cooking zones.
- **Keep** the hotplates clean at all times – dirty plates waste energy and could result in permanent discolouration of the glass.
- Take advantage of the residual heat: turn the hotplates off 5-10 minutes before the end of the cooking time.

Operation of the hotplates

General

The hotplate is OFF when the “0” is next to the dot.

The output can be varied by turning the control knobs clockwise or anticlockwise.

Simmering and frying on the hotplates

Simmering

To heat up, select setting 3 and turn back to 1 for simmering; use the higher or lower setting as required.

Frying



Heat the frying pan on setting 3, then add the food to be fried and turn back to setting 2; use higher or lower settings as required.

Control knob Setting	Suitable for:
3	Rapid heating of fat and water
2-3	Fast frying of meat, fish
2	Slow frying, making a roux
1-2	Boiling large quantities of food, stews and soups
1	Simmering potatoes, soups
0-1	Simmering vegetables, fish in its own juice
0	Residual heat and OFF position

Operation of the hotplates



Roaster plate

Switch on the round Halogen hotplate (18.0 cm) as described under “Simmering and frying”.

The roaster plate is activated by means of touch control  (figure 4/F). The symbol  glows with a red control light.

Dual circuit hotplate

The small diameter hotplate (12 cm) is switched on as described under “Simmering and frying”.

The dual circuit is activated by means of touch control  (figure 4/E). The symbol  glows with a red control light.

The small diameter hotplates are switched off as normal.

Should you wish to use both the dual circuit

and roaster plates together – follow instructions above but press **4/E** and **4/F** one after the other, not together.

Care and cleaning of the ceramic hob

Care

- Use only pans with smooth, flat bases intended for use on electric cookers.
Never use pans with a rough base, eg cast iron, or enamel pots with an electro-graphite base – these will scratch the cooking area.
- **Always** dry the pan base before placing it on the cooking area – scale deposits will damage the cooking area.
- **Always** select the correct pan size for the hotplate.
- Place the pan in the centre of the hotplate.
- **Do not** use the ceramic hob as a chopping board – dirt and food residues (especially those containing sugar) will burn in whilst cooking is in progress and damage the cooking area. Grains of sand will leave scratches on the cooking area.
- Take care not to scratch the surface of the ceramic glass with sharp edged jewellery (eg diamond ring).
- **Do not** scatter sugar or allow sugar solutions (jam, jelly, etc) to boil over onto the hot surface, as permanent damage may occur.

Cleaning

Clean the hob thoroughly before using it for the first time and at regular intervals afterwards.

General rules

- You should not clean the hob until it has cooled to the point where it is safe to touch. It is easier to clean when cold, or just warm, and there is no risk of burning yourself.
- **After EVERY cleaning, wipe over the surface with a damp cloth, then polish dry.** Do not use sponges or washing up cloths which have been used for other purposes.
- Make sure that all traces of cleaning products are moistened and thoroughly wiped off – if not, they could have a corrosive effect when the surface is reheated.
- **Never** use pan cleaners or scouring powders, soap impregnated steel wool or sponges with a rough, abrasive surface, chemical cream cleaners, bleaching agents, rust and stain removers; all these have a corrosive effect and can damage the glass surface.

Care and cleaning of the ceramic hob

Cleaning procedure

1. Clean the ceramic hob after every use with a clean, damp cloth and a little washing up liquid. Then wipe the cooking area dry with a clean cloth. No detergent residues should remain on the surface.
2. For light to normal soilage, clean the entire hob with Stahl-fix * or Sidol Edelmetallglanz *. Then rinse the entire cooking area thoroughly with clean water and wipe dry with a clean cloth. No detergent residues should remain on the surface.
3. For normal use, the hob should be conditioned once a week. We recommend the use of "Collo profi" * or "Cera-fix" * which have been developed especially for this purpose. Collo profi and Cera-fix clean and protect the hob by creating a silicon film which acts as a water and dirt repellent. Use of the conditioning products will ensure that the hob is easy to clean and offers protection against damage from sugar and highly sweetened food stuffs.

* All these cleaning products are available from AEG Spare Parts Department.

Heavy soiling and stains

Clean spillages off the hob after every use

- **Mineral deposits**, present in hard water and food, may cause discolouration in the form of grey, mother of pearl stains which appear to be on the surface. Clean such discolourations while the cooking area is still warm (not hot). Then clean the cooking area as described under 2. and 3.

If the calcareous deposits have turned brown, they are already quite severe and the only way of removing them is intensive cleaning, which may have to be repeated several times.

- **Boiled over food** should first be wiped with a damp cloth and dirt residues finally removed with a glass or razor blade scraper *. Then clean as described under 2.
- **Burnt on sugar or molten plastic** should be immediately removed when still hot – with a glass scraper. Clean the cooking area as described under 2.

Do not allow spillages to become burnt into the surface by repeated heating.

* Available via AEG Spare Parts Department.

Installation instructions

For the installer

Safety instructions

- According to the technical connection conditions of the electricity board serving your area, the appliance may only be connected to the mains supply by an approved electrical installer.
- In the fixed connection, a device allowing the appliance to be isolated on all poles from the mains supply with a contact opening width of at least 3 mm must be provided. Suitable isolating devices are Cooker Control Units.
- In respect of fire protection, the appliance conforms to type Y (IEC 335-2-6). Only appliances of this type may be installed on one side of adjacent upright kitchen housings or walls.
- Access protection must be ensured by installation.
- **The distance between the hob and vapour extractor hood must be of the extent indicated in the installation instructions of the vapour extractor hood.**

Electrical connection of appliance

Local and national electrical regulations must be observed.

All instructions given by the Electricity Board must be followed carefully when connecting the oven to the mains supply.

The appliance is rated for 240 volts single phase and must be permanently connected.

The hob must be installed in such a way that it can be easily disconnected from the mains supply before servicing, eg by an adjacent cooker control unit.

Sufficient cable should be left to enable the hob to be removed from the work surface whilst still connected to the mains supply (approximately 1.5 metres or 5 ft).

When pushing the hob into the cutout of the furniture housing, make sure that the mains cable is neither kinked nor trapped under the appliance.

Warning – This appliance must be earthed!

Voltage and Current

Please ensure that the voltage and current indicated on the rating plate agrees with the voltage of your electricity supply.

220/240 volts (ie 220/240 V a.c.).

After installation there must be no access to live parts.

For the kitchen furniture installer

Safety instructions

Please note that veneers and plastic coatings on the unit housings must be treated with heat-resistant adhesive (100 °C). Unless the plastic coatings and adhesives are heat-resistant, the coating may deform or come loose.

The use of solid wood wall upstands behind the hob is allowable so long as the minimum distances indicated in the hob diagrams are complied with.

Surface discolourations of the wall upstand are not due to temperature effects of the appliance.

For temperature reasons, cut out any upper panels of base units below the hob.

Owing to the **risk of fire**, ensure that no flammable or thermally deformable objects are placed directly below the hob.

Do not install a drawer below build-in hobs.

An intermediate panel must be fitted, that can only be detached with tools, **at least 50 mm** beneath the hob **for safety (contact protection) reasons**.

There should be no cross-strips below the worktop cutout. They should be sawn back at least as far as the worktop cutout size.

The minimum distances of hob cutouts to the rear are indicated in the installation diagrams (**figure 5**).

During installation beside an upright kitchen housing, a **safety distance of at least 50 mm** must be ensured. The side surface of the upright kitchen housing should be lined with heat-resistant material.

For reasons of good working practice, the distance laterally to upright kitchen units should be **at least 300 mm**.

The distance between the hob and vapour extractor hood must be of the extent indicated in the installation instructions of the vapour extractor hood.

Hob Cutout

Use the template supplied for your "Soft Line" ceramic hob.

Figure 5

Hobs with a width of 77 cm should be fitted over only two 60 cm base units (rather than three) to avoid the loss of the third drawer space. Please make sure that the cutout is accurately made. You should therefore use only a good, straight fretsaw blade or else a routing cutter.

The cutting surfaces must be sealed.

The range of the clamping brackets extends from 30 mm to 40 mm. With thicker worktops recesses should be provided in the worktop at suitable points.

The clamping brackets are fastened according to **figure 6/1,2**.

Hob Installation

1. Take the mean according to **figure 8**.
2. Attach fixing bracket to **figure 9**.
3. Cut off top half fixing brackets (**figure 10**) with a knife.
4. Insert hob according to (**figure 7**) and place it horizontally, level in the worktop.
5. The **two** clamps firmly fitted on both sides will grip under the fixing brackets (**figure 11**) and retain the hob. For removing it proceed in reverse order.

Important

Under no circumstances should drawers be fitted in either of the base units straddled by the hob.

For the kitchen furniture installer

Rating plate

Please state the product number (E. No.) and the serial number (F. No.) of the hob; these will be found on the information sheet accompanying this hob.

The data given should be quoted for the purpose of servicing and when ordering spare parts.

Please enter this data on the back of these instructions.

Indication of these numbers enables the Service Department to make precise identification of the required spare parts so that your hob can be repaired on the engineer's first visit.

"CE" This appliance is in conformity with the following EC Directives:

- 72/23/CEE issued 19 Feb. 1973,
Low Voltage Directive.
 - 89/336/CEE issued 3 May 1989
(Including amendment Directive
92/31/CEE), EMC Directive.
-